

Art. 6313035

ROD POD SET

[ITA] 3 canne con fodero
[ENG] Rod pod set 3 rods - cloth bag
[FRA] Set rod pod 3 cannes - forreau tissu
[ESP] Rod pod set 3 cañas - con funda

(Min. pack 5 pcs)

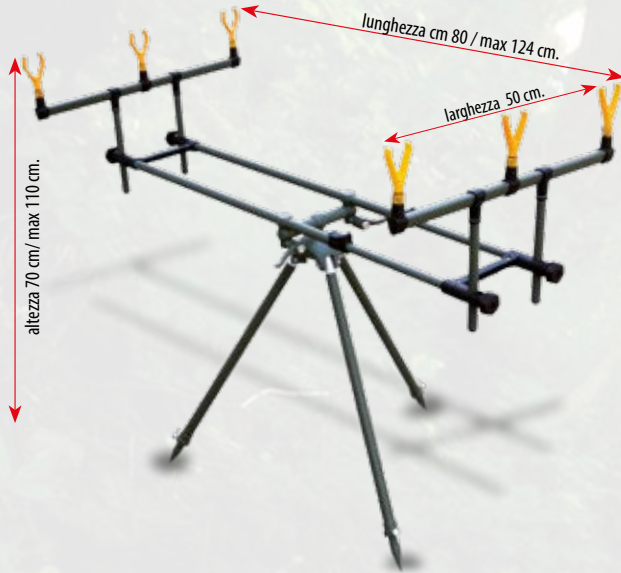

PRICE / PC

Art. 6313034

ROD POD SET

[ITA] 3 canne con fodero - piedi scorrevoli
[ENG] Rod pod set 3 rods - sliding feet - cloth bag
[FRA] set rod pod 3 cannes - pieds glissants - forreau tissu
[ESP] rod pod set 3 cañas - pies corredizos - con funda

(Min. pack 5 pcs)



PRICE / PC

Art. 6313033

ROD POD SET

[ITA] 4 canne - con fodero
[ENG] Rod pod set 4 rods - cloth bag
[FRA] Set rod pod 4 cannes - fourreau tissu
[ESP] Rod pod set 4 cañas - con funda

(Min. pack 5 pcs)



PRICE / PC

Art. 6313043

ROD POD SET SPECIAL

[ITA] 3 canne con fodero in cordura®
[ENG] Rod pod set 3 rods - cloth bag
[FRA] Set rod pod 3 cannes - forreau tissu
[ESP] Rod pod set 3 cañas - funda de cordura®

(Min. pack 4 pcs)

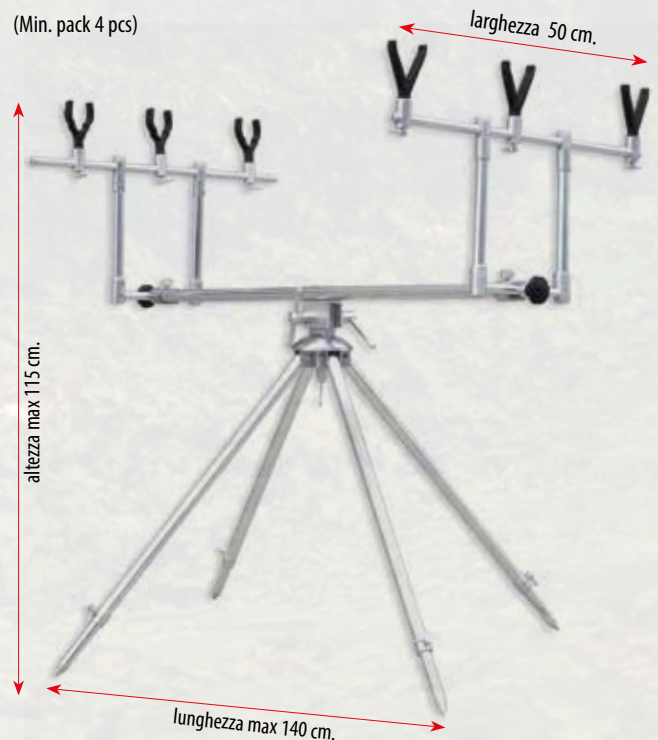

PRICE / PC

Art. 6313049

ROD POD SET

[ITA] 3 canne
[ENG] Rod pod set 3 rods
[FRA] Set rod pod 3 cannes
[ESP] Rod pod set 3 cañas

(Min. pack 6 pcs)

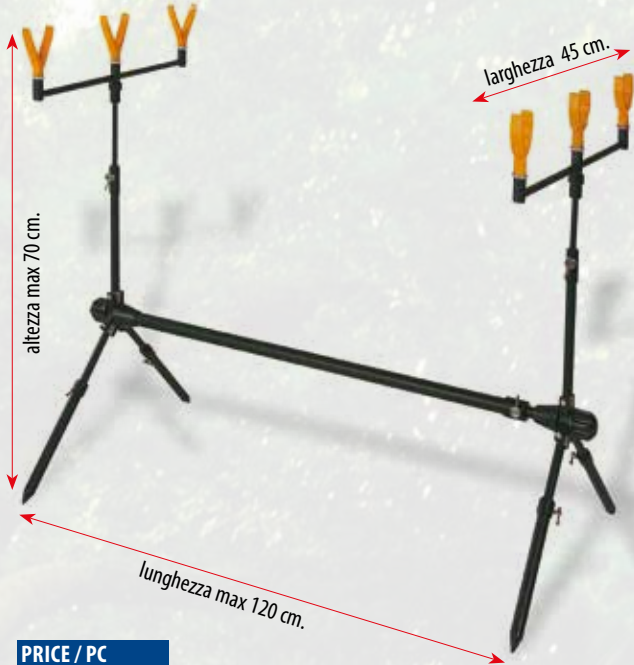

PRICE / PC

Art. 6313056

ROD POD SET

[ITA] 3 canne
[ENG] Rod pod set 3 rods
[FRA] Set rod pod 3 cannes
[ESP] Rod pod set 3 cañas

(Min. pack 6 pcs)

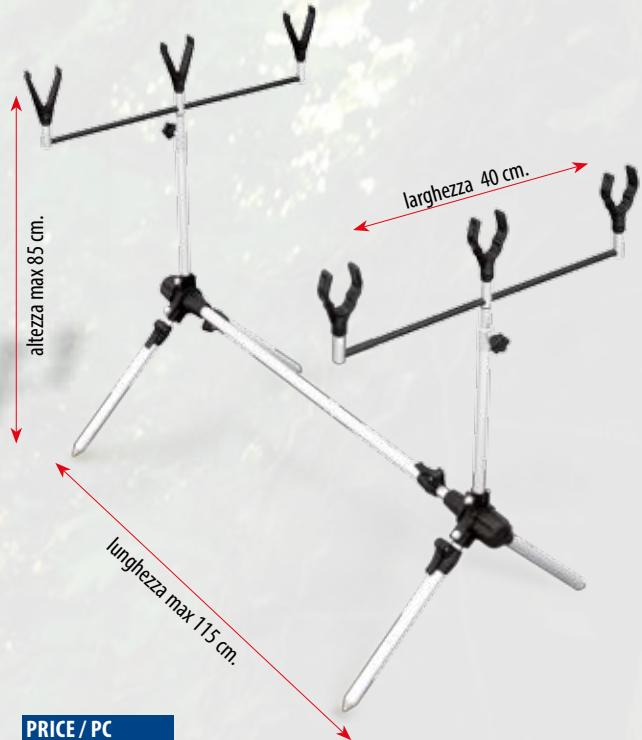

PRICE / PC

Art. 6313014

ROD POD SET

[ITA] per 3 canne - 3 swingers inclusi - con fodero
[ENG] Rod pod set 3 rods - 3 swingers included - cloth bag
[FRA] Set rod pod 3 cannes - 3 swingers inclus - avec fourreau
[ESP] Rod pod set 3 cañas - 3 swingers incluidos - con funda

(Min. pack 6 pcs)

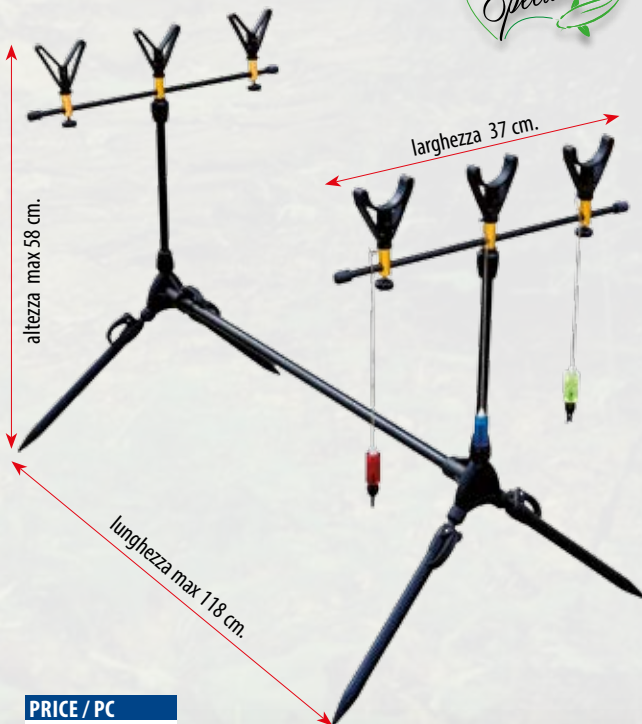

PRICE / PC

ROD POD SET

[ITA] alluminio - regolazione di 2 piedi
[ENG] aluminium - 2 adjustable stands
[FRA] aluminium - 2 pieds réglables
[ESP] aluminio - 2 pies ajustables

(Min. pack 6 pcs)

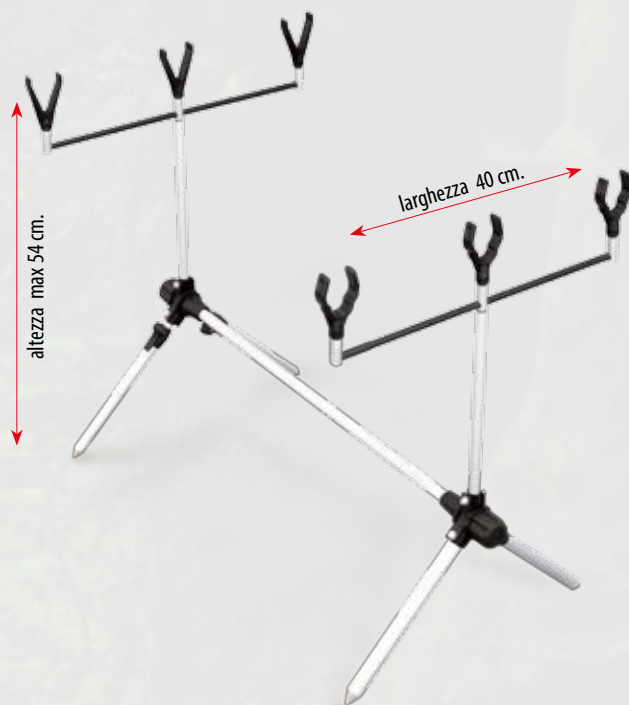

INFO	ROD POD SET		
CODE	RODS	LENGTH CM	PRICE / PC
6313019	3	100	



Art. 6313061

REGGICANNA ANTERIORE

[ITA] Vite ottone
[ENG] Brass screw head rest front
[FRA] Support avant vis laiton
[ESP] Portacañas delantero tornillo de latón

(Min. pack 10 pcs.)



PRICE / PC

Art. 6313075

REGGICANNA POSTERIORE

[ITA] Morbido vite ottone
[ENG] Soft Brass screw head rest back
[FRA] Support arrier souple vis laiton
[ESP] Portacañas posterior morbido con tornillo de latón

(Min. pack 10 pcs.)



PRICE / PC

Art. 6313063

REGGICANNE POSTERIORE

[ITA] Vite ottone
[ENG] Brass screw head rest back
[FRA] Support arriere vis laiton
[ESP] Portacañas posterior tornillo de latón

(Min. pack 10 pcs.)



PRICE / PC

Art. 6313076

REGGICANNA POSTERIORE

[ITA] Morbido vite ottone
[ENG] Soft Brass screw head rest back
[FRA] Support arrier souple vis laiton
[ESP] Portacañas posterior morbido con tornillo de latón

(Min. pack 10 pcs.)



PRICE / PC

Art. 6313074

REGGICANNE POSTERIORE

[ITA] Fosforescente con vite in acciaio
[ENG] Phosphorescent head rest back - SS screw
[FRA] Support arriere phosphorescent - vis acier
[ESP] Portacañas posterior tornillo de acero

(Min. pack 10 pcs.)



GLOWING

PRICE / PC

Art. 6313073

REGGICANNE POSTERIORE

[ITA] Fosforescente con vite in acciaio
[ENG] Phosphorescent head rest back - SS screw
[FRA] Support arriere phosphorescent - vis acier
[ESP] Portacañas posterior tornillo de acero

(Min. pack 10 pcs.)



GLOWING

PRICE / PC

Art. 6301008

TESTA REGGICANNE INGLESE

[ITA] Snodato vite ottone
[ENG] Brass screw head quiver flexy rest
[FRA] Support canne quiver vis laiton articulé
[ESP] Cabeza portacañas ingles articulado tornillo latón

(Min. pack 10 pcs.)



PRICE / PC

Art. 6313070

REGGICANNE A "V" CENTRALE

[ITA] Snodato con vite ottone
[ENG] Jointed V-shape rod rest with brass screw head
[FRA] Support à «v» articulé avec vis en laiton
[ESP] Portacañas a "v" articulado con tornillo de latón

(Min. pack 10 pcs.)



PRICE / PC

Art. 6313005

PORTAPESCI TROTA SPECIAL

[ITA] per pesca in lago - 2 reggicanna
[ENG] Special lake trout keep container - 2 rod holders
[FRA] Porte poissons special truite en lac - 2 supports pour cannes
[ESP] Portapeces special pesca de la trucha en lago - 2 portacañas

(Min. pack 6 pcs)



PRICE / PC

Art. 6313000

PORTACANNE TROTA 6 POSTI

[ITA] per pesca in lago
[ENG] holder with 6 rod rests for lake trout fishing
[FRA] support cannes à 6 logements pour la peche à la truite en lac
[ESP] portacaña trucha lago - 6 ranuras

(Min. pack 6 pcs)

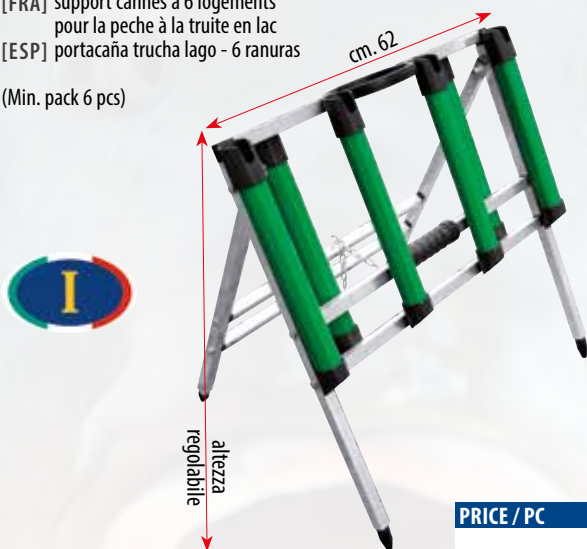

PRICE / PC

Art. 6313001

PORTACANNE TROTA 8 POSTI

[ITA] per pesca in lago
[ENG] holder with 8 rod rests for lake trout fishing
[FRA] support cannes à 8 logements pour la peche à la truite en lac
[ESP] portacaña trucha lago - 8 ranuras

(Min. pack 6 pcs)

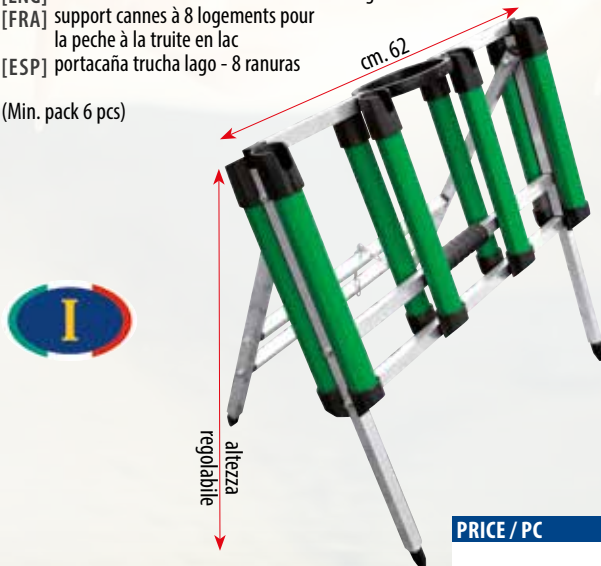

PRICE / PC

ROLLER PORTACANNE

[ITA] Piedi regolabili
[ENG] Adjustable roller rod holder
[FRA] Support cannes roller réglable
[ESP] Roller portacañas ajustable

(Min. pack 10 pcs.)



INFO	ROLLER PORTACANNE	
CODE	SIZE (CM.)	PRICE / PC
6313024	36X37	

TRIPODE PORTACANNE

[ITA] Telescopico in alluminio
[ENG] Aluminium telescopic tripod
[FRA] Trépied télescopique en aluminium
[ESP] Tripode telescopico de aluminio

(Min. pack 10 pcs.)

[ITA] Incluso reggicanna in EVA a 6 posti
[ENG] EVA rest for 6 rods included
[FRA] Support en EVA pour 6 cannes inclus
[ESP] Suporte de EVA para 6 cañas incluido



INFO	MINI TRIPODE	
CODE	CLOSED SIZE (CM.)	PRICE / PC
6313038	65	



TRIPODE ALLUMINIO ESTENSIBILE

[ITA] Tripode alluminio estensibile
 [ENG] Foldable aluminium rod holder
 [FRA] Support cannes aluminium extensible
 [ESP] Tripode aluminio extensible

(Min. pack 25 pcs.)

new



INFO	ALUMINIUM TRIPOD	
CODE	SIZE (CM.)	PRICE / PC
6313045	165 / 3 SECTIONS	
6313046	80 / 2 SECTIONS	
6313047	120 / 3 SECTIONS	

TRIPODE ALLUMINIO TELESCOPICO SURF CASTING

[ITA] ad inclinazione regolabile - con fodero
 [ENG] Surf adjustable telescopic tripod with cloth bag.
 [FRA] Tripode réglable telescopique surf-casting aluminium avec fourreau
 [ESP] Tripode aluminio telescopico surf casting con inclinación regulable con funda

(Min. q.ty 10 pc.)



INFO	ALUMINIUM TRIPOD	
CODE	SIZE (CM.)	PRICE / PC
6313042/N	200	

TRIPODE ALLUMINIO SPECIAL TELESCOPICO SURF CASTING

[ITA] ad inclinazione regolabile - con fodero
 [ENG] Surf adjustable telescopic tripod with cloth bag.
 [FRA] Tripode réglable telescopique surf-casting aluminium avec fourreau
 [ESP] Tripode aluminio telescopico surf casting con inclinación regulable con funda

(Min. q.ty 6 pc.)

new

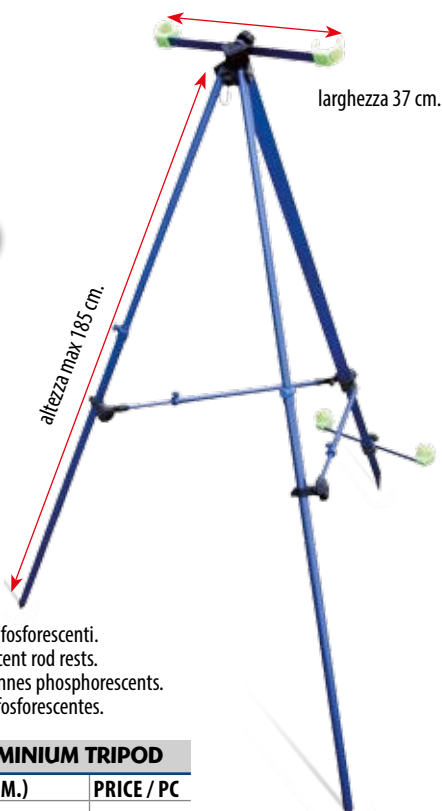

[ITA] Reggicanna fosforescenti.
 [ENG] Phosphorescent rod rests.
 [FRA] Supports cannes phosphorescents.
 [ESP] Portacañas fosforescentes.

INFO	ALUMINIUM TRIPOD	
CODE	SIZE (CM.)	PRICE / PC
6313041	185	

TRIPODE ALLUMINIO SURF CASTING

[ITA] ad inclinazione regolabile
 [ENG] Surf adjustable aluminium tripod.
 [FRA] Tripode réglable surf-casting en aluminium.
 [ESP] Tripode aluminio surf casting inclinación regulable.

(Min. q.ty 10 pc.)

new

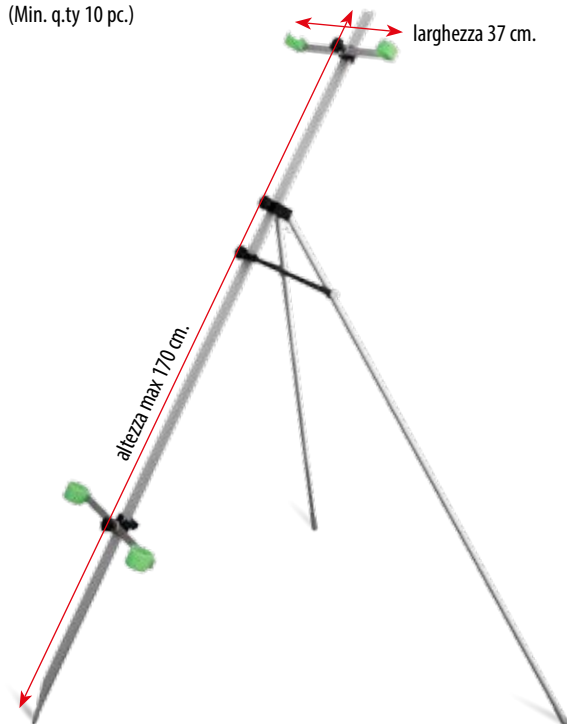

INFO	ALUMINIUM TRIPOD	
CODE	SIZE (CM.)	PRICE / PC
6313044	170	

TRIPODE ALLUMINIO TELESCOPICO CON VASCHETTA

[ITA] ad inclinazione regolabile - con fodero.
 [ENG] Surf adjustable telescopic tripod with side tray - cloth bag.
 [FRA] Tripode réglable télescopique aluminium avec plateau et fourreau.
 [ESP] Tripode aluminio telescópico surf casting inclinación regulable con serbidora y funda.

(Min. q.ty 6 pc.)



Art. 6313040/N

Reggicanna fosforescenti. [ITA]
 Phosphorescent rod rests. [ENG]
 Supports cannes phosphorescentes. [FRA]
 Portacañas fosforescentes. [ESP]

PRICE / PC

Art. 6533074

VASCHETTA "SERBIDORA" PER TRIPODI

new

[ITA] cm 31,5x26 - con aggancio universale regolabile.
 [ENG] Side tray for surf tripods - unifit adjustable joint.
 [FRA] Plateau lateral pour tripodes surf - jonction universelle réglable.
 [ESP] Serbidora lateral para tripodes surf - enganche universal ajustable.

(Min. q.ty 6 pc.)



PRICE / PC

Art. 6313048

TRIPODE MONO CANNA

[ITA] Alluminio cm 120
 [ENG] Aluminium tripod for 1 rod.
 [FRA] Tripode en aluminium pour 1 canne.
 [ESP] Tripode de aluminio por 1 caña.

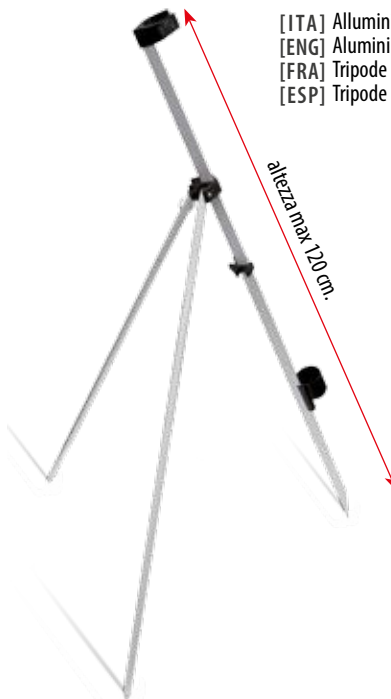

(Min. q.ty 6 pc.)

new

PRICE / PC

Art. 6313050

TRIPODE TROUT AREA

[ITA] 3 canne, alluminio, cm 80
 [ENG] Trout area alu tripod for 3 rods.
 [FRA] Tripode en aluminium pour 3 cannes.
 [ESP] Tripode Trout Area de aluminio por 3 cañas.

new



(Min. q.ty 6 pc.)

PRICE / PC

Art. 6325...

PICCHETTO IN ALLUMINIO

[ITA] Picchetto in alluminio telescópico regolabile
 [ENG] Fully adjustable bank aluminium stick
 [FRA] Support télescopique réglable en aluminium
 [ESP] Portacañas telescópico ajustable de aluminio

(Min. q.ty 25 pcs.)



INFO PICCHETTO IN ALLUMINIO

CODE	SIZE (CM.)	PRICE / PC
6325041	40-70	
6325061	50-100	
6325076	75-140	
6325126	125-230	



Art. 6301200
PICCO BIFILETTATO

[ITA] in alluminio telescopico chiuso cm. 90, aperto cm. 160
[ENG] Aluminium telescopic bank stick with double thread, closed cm. 90, opened cm. 160
[FRA] Pique telescopique en aluminium filetage double fermé 90 cm., ouvert 160 cm.
[ESP] Piqueta telescopica de aluminio cerr. cm. 90 abierta cm. 160
(Min. q.ty 25 pcs.)

PRICE / PC



Art. 6302200
PICCHETTO A "U"

[ITA] Telescopico reggicanna posteriore chiuso cm. 80, aperto cm. 130
[ENG] Telescopic rod holder - back, closed cm. 80, opened cm. 130
[FRA] Support telescopique postérieur, fermé cm. 80, ouvert cm. 130
[ESP] Portacañas telescopico posterior cerr. cm. 80 abierto cm. 130
(Min. q.ty 50 pcs.)

(Min. q.ty 50 pcs.)

PRICE / PC



Art. 6302100
PICCHETTO A "V"

[ITA] Telescopico reggicanna anteriore chiuso cm. 80, aperto cm. 130
[ENG] Telescopic rod holder - front, closed cm. 80, opened cm. 130
[FRA] Support telescopique antérieur, fermé cm. 80, ouvert cm. 130
[ESP] Portacañas telescopico delantero cerr. cm. 80 abierto cm. 130
(Min. q.ty 50 pcs.)

(Min. q.ty 50 pcs.)

PRICE / PC



Art. 6301080
PICCO FISSO

[ITA] Passo italiano cm. 80
[ENG] Aluminium bank stick length cm. 80
[FRA] pique fixe en aluminium 80 cm.
[ESP] Piqueta fija de aluminio cm. 80
(Min. q.ty 25 pcs.)

PRICE / PC



Art. 6313089
JUMBO LUNGO

[ITA] Chiuso cm. 70, aperto cm. 120
[ENG] Jumbo long, closed cm. 70, opened cm. 120
[FRA] Porte-canne long, fermé 70 cm., ouvert 120 cm.
[ESP] Portacañas largo cerr. cm. 70 abierto cm. 120
(Min. q.ty 25 pcs.)

(Min. q.ty 25 pcs.)

PRICE / PC



Art. 6313088
JUMBO CORTO

[ITA] Chiuso cm. 55, aperto cm. 80
[ENG] Jumbo short closed cm. 55 - open cm. 80
[FRA] Porte-canne court, fermé cm. 55, ouvert cm. 80
[ESP] Portacañas corto cerr. cm. 55 abierto cm. 120
(Min. q.ty 25 pcs.)

(Min. q.ty 25 pcs.)

PRICE / PC



Art. 6301152
PICCHETTO A "V"

[ITA] Reggicanna anteriore monopezzo cm. 80
[ENG] Monosection rod holder - front cm. 80
[FRA] Support monosection antérieur cm. 80
[ESP] Portacañas 1 sección delantero cm. 80
(Min. q.ty 50 pcs.)

(Min. q.ty 50 pcs.)

PRICE / PC



Art. 6313081
REGGICANNE TELESCOPICO

[ITA] "Rock 2" chiuso cm. 70, aperto cm. 90
[ENG] Rod rest - closed cm. 70 - open cm. 90
[FRA] Support porte-canne - fermé cm. 70 - ouvert cm. 90
[ESP] Portacañas telescopico "rock 2" cerrado cm. 70 abierto cm. 90
(Min. q.ty 25 pcs.)

(Min. q.ty 25 pcs.)

PRICE / PC



Art. 6313082
REGGICANNE TELESCOPICO

[ITA] "Rock 3" chiuso cm. 90, aperto cm. 120
[ENG] Rod rest - closed cm. 90 - open cm. 120
[FRA] Support porte-canne fermé cm. 90 - ouvert cm. 120
[ESP] Portacañas telescopico cerr. cm. 90 abierto cm. 120
(Min. q.ty 25 pcs.)

(Min. q.ty 25 pcs.)

PRICE / PC



PICCHETTO FILETTATO

[ITA] Telescopico in alluminio
[ENG] Telescopic aluminium rod holder
[FRA] Support telescopique aluminium.
[ESP] Portacañas telescopico de aluminio
(Min. q.ty 50 pcs.)

(Min. q.ty 50 pcs.)

INFO

PICCHETTO

CODE	OPEN / CLOSED	PRICE / PC
6301150	50-90 CM	
6301151	85-160 CM	



REGGICANNE DA BARCA

[ITA] Reggicanne da barca regolabile
 [ENG] Adjustable boat rod holder
 [FRA] Support de canne réglable pour bateau
 [ESP] Portacañas ajustable para barco

(Min. q.ty 20 pcs.)



INFO REGGICANNE DA BARCA		
CODE	SIZE	PRICE / PC
6302400	SMALL	
6302405	BIG	

Art. 6313995

CLONK

[ITA] in legno per pesca al siluro
 lunghezza cm. 38 - peso 90 g.
 [ENG] Cat fish CLONK
 length cm. 38 - weight 90 g.
 [FRA] Clonk en bois pour pêche au silure
 longueur cm. 38 - poids 90 g.
 [ESP] Clonk de madera para siluros
 largura cm. 38 - peso 90 g.

(Min. q.ty 25 pcs.)

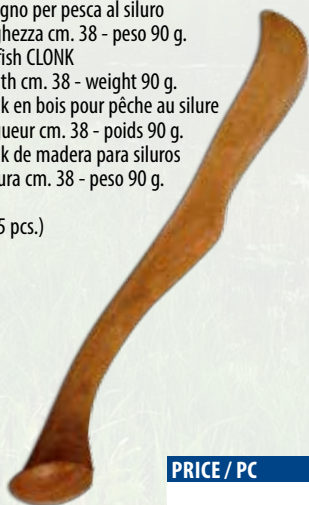

PRICE / PC

PUNTALE SABBIA

[ITA] Regolabile alluminio e plastica fluorescente
 [ENG] Aluminium and fluo plastic adjustable
 sand rod holder
 [FRA] Porte canne sable réglable en aluminium
 et plastique fluorescente
 [ESP] Contera para arena ajustable
 de aluminio
 y plastico fluorescente

(Min. q.ty 25 pcs.)



INFO PUNTALE		
CODE	SIZE (CM.)	PRICE / PC
6302211	100	
6302212	125	
6302213	75	

Art. 6313072

PUNTALE REGGICANNE

[ITA] Moplen pieghevole cm. 35
 [ENG] Moplen rod holder cm. 35
 [FRA] Support de canne repliable cm. 35
 [ESP] Portacañas moplen plegable cm. 35

(Min. q.ty 50 pcs.)



PRICE / PC

Art. 6320050

FISH FINDER STAND

[ITA] Supporto per ecoscandaglio da barca
 [ENG] Boat fish finder stand
 [FRA] Support échosondeur pour bateau
 [ESP] Suporte ecosondas para barco



INFO FISH FINDER STAND		
CODE	LENGTH (CM.)	PRICE / PC
6320050	90	

Art. 6320015

MANICO FIOCINA CON ELASTICO

(Min. q.ty 50 pcs.)

PRICE / PC

[ITA] 1 sezione - lunghezza totale cm. 120
 [ENG] Spear handle , 1 section- total length cm. 120
 [FRA] Poignée harpon 1 section- longueur totale cm 120.
 [ESP] Mango arpón - 1 sección - largura cm. 120

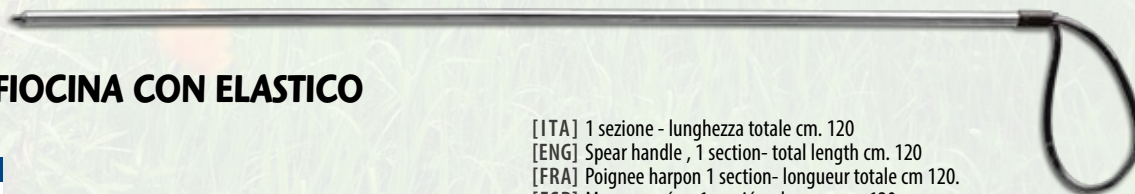

Art. 6320017

FIOCINA A 5 PUNTE

[ITA] Fiocina a 5 punte
 [ENG] 5 heads fork spear
 [FRA] Harpon à 5 pointes
 [ESP] Arpon con 5 puntas

(Min. q.ty 50 pcs.)



PRICE / PC

Art. 6320016

FIOCINA A TRIDENTE

[ITA] Fiocina a tridente
 [ENG] 3 heads fork spear
 [FRA] Harpon à 3 pointes
 [ESP] Arpon con 3 puntas

(Min. q.ty 50 pcs.)



PRICE / PC

Art. 6320010

FIOCINA A TRIDENTE CON ELASTICO

(Min. q.ty 50 pcs.)

[ITA] 1 sezione - lunghezza totale cm. 120
[ENG] 3 heads fork spear, 1 section- total length cm. 120
[FRA] Harpon à trident, 1 section- longueur totale cm 120
[ESP] Arpón con 3 puntas - 1 sección - largura cm. 120

PRICE / PC

Art. 6320011

FIOCINA A 5 PUNTE CON ELASTICO

(Min. q.ty 50 pcs.)

[ITA] 1 sezione - lunghezza totale cm. 120
[ENG] 5 heads fork spear, 1 section- total length cm. 120
[FRA] Harpon à 5 pointes, 1 section- longueur totale cm 120
[ESP] Arpón con 5 puntas - 1 sección - largura cm. 120

PRICE / PC

318

Art. 63200...

RAFFIO TELESCOPICO

[ITA] Acciaio e alluminio - in 2 pz. Misura grande specifica per prede di grossa taglia

[ENG] Telescopic boat-hook in 2 sections, aluminium and stainless steel.

Big size specific for big preys

[FRA] Gaffe telescopique acier et aluminium - deux elements.

Taille grande spécifique pour proies de grosses tailles

[ESP] Gancho 2 elementos acero y aluminio. grande medida específica para presas grandes

(Min. q.ty 25 pcs.)

INFO	RAFFIO TELESCOPICO			
CODE	CLOSED (CM.)	OPEN (CM.)	HOOK DIAM. (MM.)	PRICE / PC
6320005	90	140	6	
6320003	133	225	8	



Art. 632002..

RAFFIO TELESCOPICO

[ITA] Acciaio e alluminio - in 2 pz.

[ENG] Telescopic boat-hook in 2 sections, aluminium and stainless steel.

Triangular section handle

[FRA] Gaffe telescopique acier et aluminium - deux elements.

Poignée à section triangulaire

[ESP] Gancho 2 elementos acero y aluminio. Mango a seccion triangular

(Min. q.ty 25 pcs.)

INFO	RAFFIO TELESCOPICO			
CODE	CLOSED (CM.)	OPEN (CM.)	HOOK DIAM. (MM.)	PRICE / PC
6320020	90	130	6	
6320021	100	160	6	
6320022	115	200	8	



Art. 6320007

MINI RAFFIO TELESCOPICO REGOLABILE

[ITA] Acciaio e alluminio - in 2 pz. Chiuso cm. 54 - aperto cm. 72

[ENG] Compact adjustable telescopic boat-hook in 2 sections, aluminium and stainless steel.

Closed cm. 54 - open cm. 72

[FRA] Gaffe telescopique réglable compact acier et aluminium - deux elements.

Fermé cm. 54 - ouvert cm. 72

[ESP] Gancho ajustable compacto 2 elementos acero y aluminio.

Cerrado cm. 54 - abierto cm. 72

(Min. q.ty 25 pcs.)



PRICE / PC

Art. 6320002

RAFFIO MONOSEZIONE

(Min. q.ty 25 pcs.)

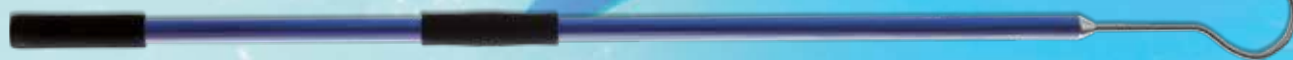

PRICE / PC

[ITA] Acciaio e fibra di vetro lunghezza totale cm. 140

[ENG] Monosection gaff, stainless steel and fiber glass total length cm. 140

[FRA] Gaffe monosection - acier et fibre de verre - longueur total cm 140

[ESP] Gancho un elemento acero y fibra de vidrio cm. 140

