

ROD STANDS

Art. 6313053

TRIPODE "ULTIMATE"

- [ITA] Completamente regolabile - con fodero.
 [ENG] Fully adjustable surf tripod - cloth bag.
 [FRA] Tripode surf entièrement réglable avec fourreau.
 [ESP] Tripode surf totalmente ajustable con funda.

(Min. q.ty 6 pc.)

**METAL
HEAVY DUTY
CONSTRUCTION**

EVA INSERTS



- [ITA] Reggicanna fosforescenti.
 [ENG] Phosphorescent rod rests.
 [FRA] Supports cannes phosphorescents.
 [ESP] Portacañas fosforescentes.

PRICE / PC

TRIPODE ALLUMINIO TELESCOPICO SURFCASTING

Art. 6313042/N

- [ITA] ad inclinazione regolabile - con fodero
 [ENG] Surf adjustable telescopic tripod with cloth bag.
 [FRA] Tripode réglable telescopique surf-casting aluminium avec fourreau
 [ESP] Tripode aluminio telescopico surf casting con inclinación regulable con funda

(Min. q.ty 10 pc.)

NEW

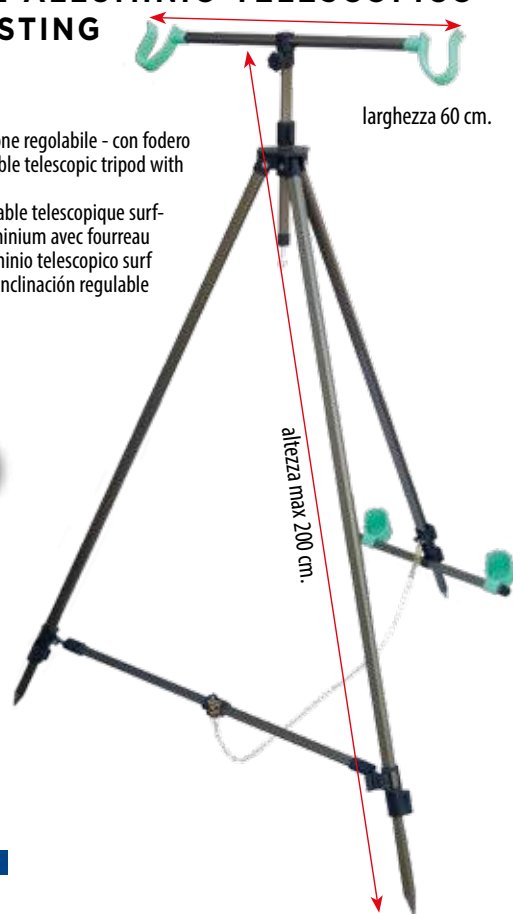

PRICE / PC

NEW

Art. 6313042

TRIPODE "DELUXE"

- [ITA] Completamente regolabile - con fodero.
 [ENG] Fully adjustable surf tripod - cloth bag.
 [FRA] Tripode surf entièrement réglable avec fourreau.
 [ESP] Tripode surf totalmente ajustable con funda.

(Min. q.ty 6 pc.)

- [ITA] Reggicanna fosforescenti.
 [ENG] Phosphorescent rod rests.
 [FRA] Supports cannes phosphorescents.
 [ESP] Portacañas fosforescentes.

PRICE / PC

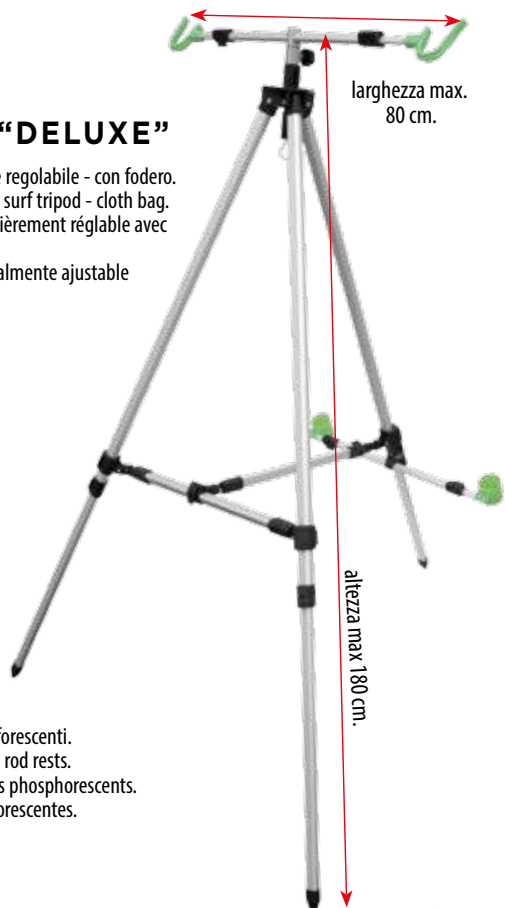

TRIPODE ALLUMINIO SPECIAL TELESCOPICO SURF CASTING

- [ITA] ad inclinazione regolabile - con fodero
 [ENG] Surf adjustable telescopic tripod with cloth bag.
 [FRA] Tripode réglable telescopique surf-casting aluminium avec fourreau
 [ESP] Tripode aluminio telescopico surf casting con inclinación regulable con funda

(Min. q.ty 6 pc.)

INFO	ALUMINIUM TRIPOD	
CODE	SIZE (CM.)	PRICE / PC
6313041	185	

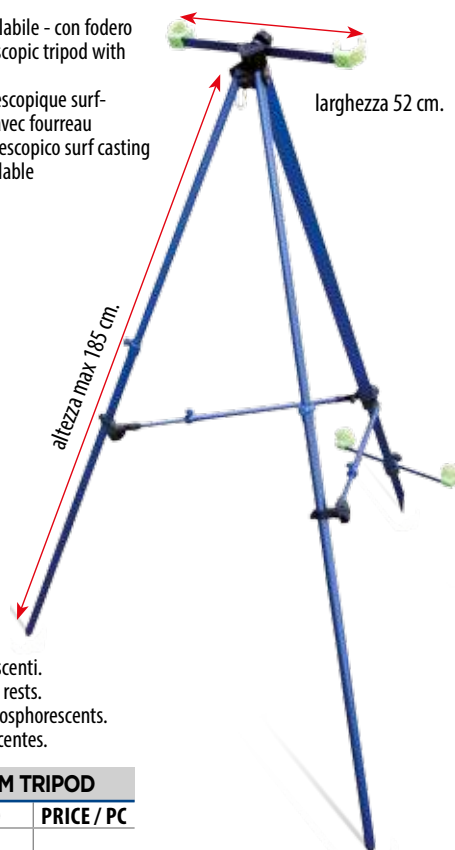

TRIPODE ALLUMINIO TELESCOPICO CON VASCHETTA

Art. 6313040/N

[ITA] ad inclinazione regolabile - con fodero.
 [ENG] Surf adjustable telescopic tripod with side tray - cloth bag.
 [FRA] Tripode réglable telescopique aluminium avec plateau et fourreau.
 [ESP] Tripode aluminio telescopico surf casting inclinación regulable con serbidora y funda.

(Min. q.ty 6 pc.)

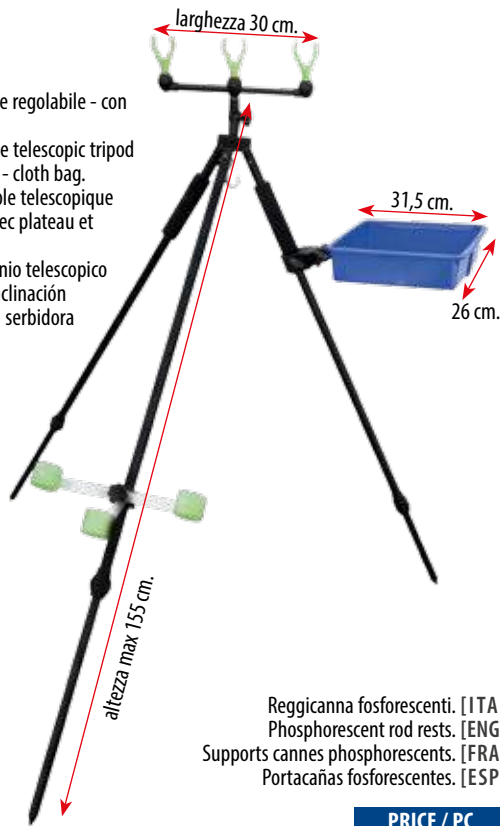

Reggicanna fosforescenti. [ITA]
 Phosphorescent rod rests. [ENG]
 Supports cannes phosphorescents. [FRA]
 Portacañas fosforescentes. [ESP]

PRICE / PC

TRIPODE ALLUMINIO SURF CASTING

[ITA] ad inclinazione regolabile
 [ENG] Surf adjustable aluminium tripod.
 [FRA] Tripode réglable surf-casting en aluminium.
 [ESP] Tripode aluminio surf casting inclinación regulable.

(Min. q.ty 8 pc.)

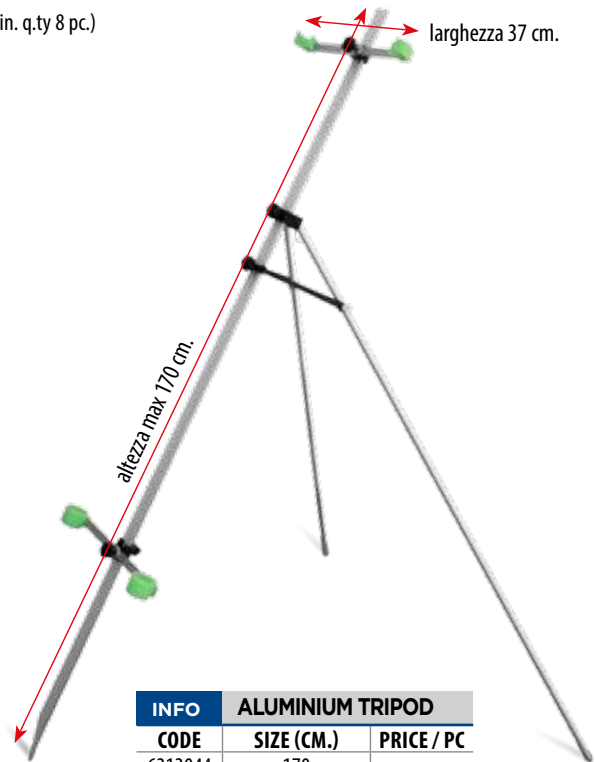

INFO	ALUMINIUM TRIPOD	
CODE	SIZE (CM.)	PRICE / PC
6313044	170	

Art. 6313055

TRIPODE "PORTO"

[ITA] Piedi e reggicanna ad altezza regolabile.
 [ENG] Adjustable height feet and rod rests.
 [FRA] Pieds et supports cannes réglables en hauteur.
 [ESP] Patas y portacañas regulables en altura.

(Min. q.ty 6 pc.)

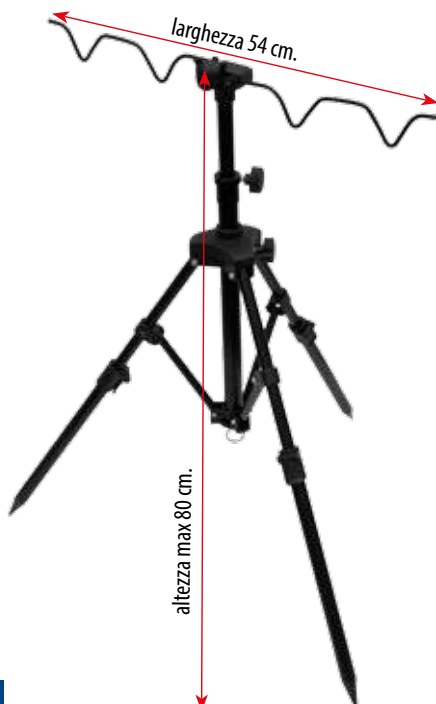

PRICE / PC

NEW

Art. 6313054

TRIPODE "TROPEA"

[ITA] Portacanna completamente orientabile.
 [ENG] Fully tilttable rod rest.
 [FRA] Support canne entièrement inclinable.
 [ESP] Portacaña completamente inclinable.

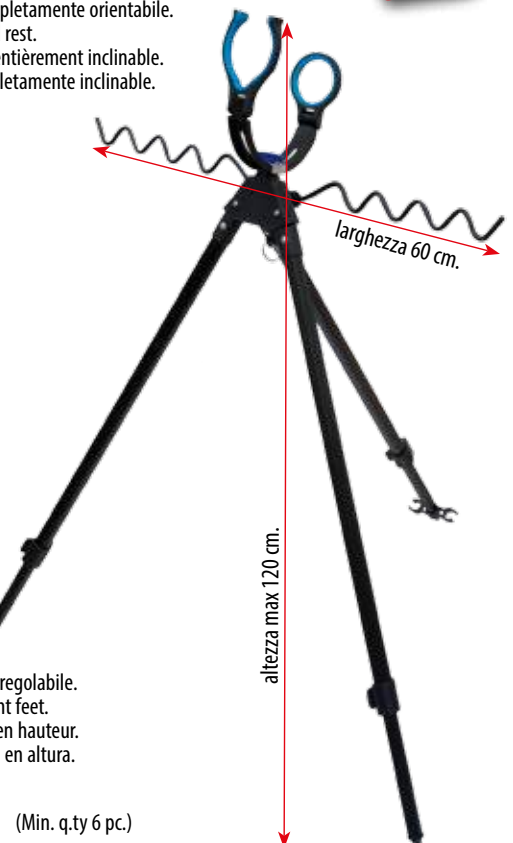

PRICE / PC

(Min. q.ty 6 pc.)

NEW

ROD STANDS

TRIPODE ALLUMINIO ESTENSIBILE

[ITA] Tripode alluminio estensibile
[ENG] Foldable aluminium rod holder
[FRA] Support cannes aluminium extensible
[ESP] Tripode aluminio extensible

(Min. pack 20 pcs.)

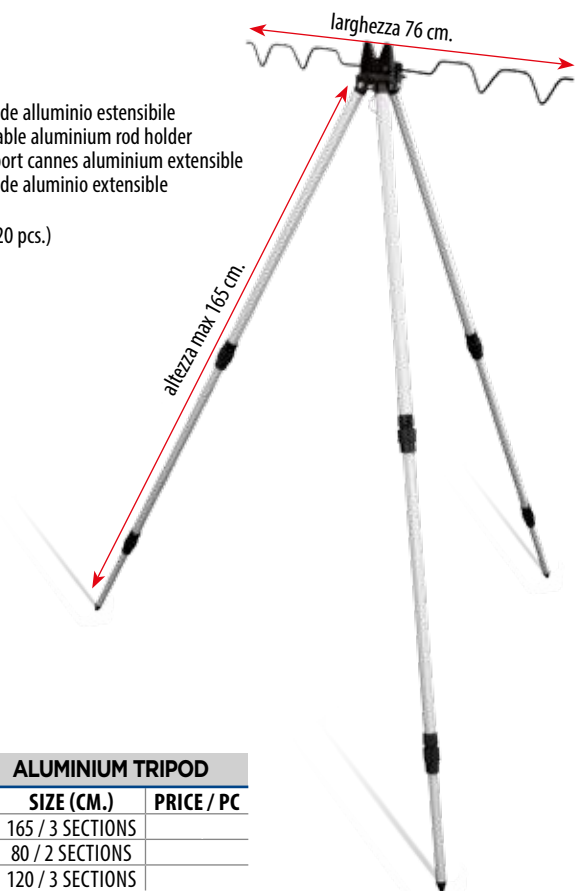

INFO	ALUMINIUM TRIPOD	
CODE	SIZE (CM.)	PRICE / PC
6313045	165 / 3 SECTIONS	
6313046	80 / 2 SECTIONS	
6313047	120 / 3 SECTIONS	

PUNTALE SABBIA

[ITA] Regolabile alluminio e plastica fluorescente
[ENG] Aluminium and fluo plastic adjustable sand rod holder
[FRA] Porte canne sable réglable en aluminium et plastique fluorescente
[ESP] Contera para arena ajustable de aluminio y plastico fluorescente

(Min. q.ty 25 pcs.)



INFO	PUNTALE	
CODE	SIZE (CM.)	PRICE / PC
6302211	100	
6302212	125	
6302213	75	
6302214	150	

Art. 6313072

PUNTALE REGGICANNE

[ITA] Moplen pieghevole cm. 35
[ENG] Moplen rod holder cm. 35
[FRA] Support de canne repliable cm. 35
[ESP] Portacañas moplen plegable cm. 35

(Min. q.ty 50 pcs.)



PRICE / PC

Art. 6313048

TRIPODE MONO CANNA

[ITA] Alluminio cm 120
[ENG] Aluminium tripod for 1 rod.
[FRA] Tripode en aluminium pour 1 canne.
[ESP] Tripode de alluminio por 1 caña.

(Min. q.ty 10 pc.)

PRICE / PC

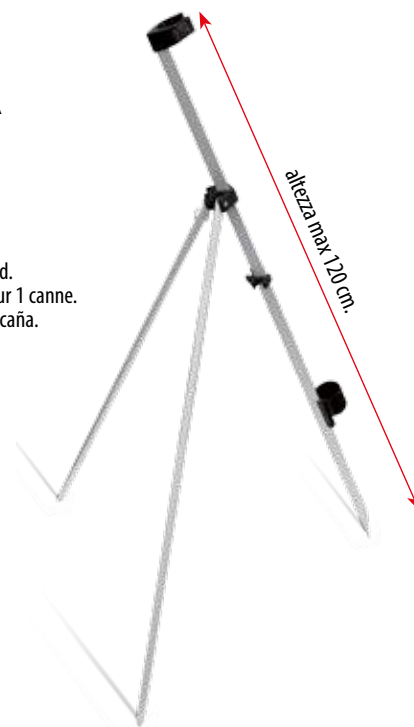

Art. 6533074

VASCHETTA "SERBIDORA" PER TRIPODI

[ITA] cm 31,5x26 - con aggancio universale regolabile.
[ENG] Side tray for surf tripods - unifit adjustable joint.
[FRA] Plateau lateral pour tripodes surf - jonction universelle réglable.
[ESP] Serbidora lateral para tripodes surf - engancho universal ajustable.

(Min. q.ty 6 pc.)

PRICE / PC



REGGICANNE DA BARCA



[ITA] Reggicanne da barca regolabile
[ENG] Adjustable boat rod holder
[FRA] Support de canne réglable pour bateau
[ESP] Portacañas ajustable para barco

(Min. q.ty 20 pcs.)

INFO	REGGICANNE DA BARCA	
CODE	SIZE	PRICE / PC
6302400	SMALL	
6302405	BIG	

Art. 6313011

TRIPODE "STURGEON"

NEW

- [ITA] Completamente regolabile
altezza max. cm 45 - blister x 2 pz.
[ENG] Fully adjustable - max. height 45 cm
blister x 2 pcs.
[FRA] Entièrement réglable - haut. max. 45 cm
blister x 2 pcs.
[ESP] Totalmente ajustable
alt. maxima 45 cm
blister x 2 uds.

(Min. q.ty 6 pcs.)



DINSMORES

SET PRICE

TRIPODE PORTACANNE

- [ITA] Telescopico in alluminio
[ENG] Aluminium telescopic tripod
[FRA] Trépied télescopique en aluminium
[ESP] Trípode telescópico de aluminio

(Min. pack 10 pcs.)

- [ITA] Incluso reggicanna in EVA a 6 posti
[ENG] EVA rest for 6 rods included
[FRA] Support en EVA pour 6 cannes inclus
[ESP] Soporte de EVA para 6 cañas incluido

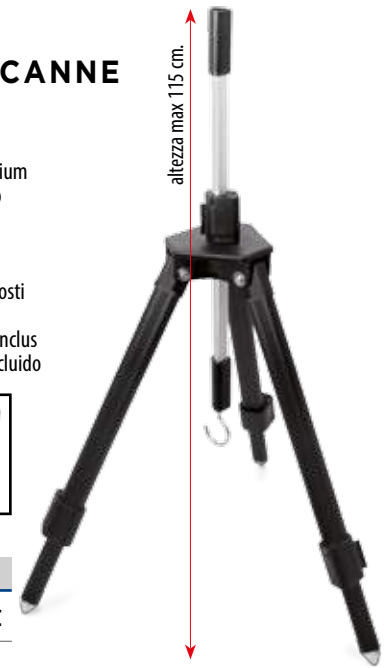

INFO	MINI TRIPODE	
CODE	CLOSED SIZE (CM.)	PRICE / PC
6313038	65	

Art. 6313050

TRIPODE TROUT AREA

- [ITA] 3 canne, alluminio, cm 80
[ENG] Trout area alu tripod for 3 rods.
[FRA] Tripode en aluminium pour 3 cannes.
[ESP] Tripode Trout Area de aluminio por 3 cañas.

(Min. q.ty 15 pc.)



PRICE / PC

Art. 6320050

BRACCIO FISH FINDER STAND

- [ITA] Supporto per ecoscandaglio da barca
[ENG] Boat fish finder stand
[FRA] Support échosondeur pour bateau
[ESP] Soporte ecosondas para barco



INFO	FISH FINDER STAND	
CODE	LENGTH (CM.)	PRICE / PC
6320050	90	

PICCHETTO JUMBO

- [ITA] Porta canne
[ENG] Jumbo
[FRA] Porte-canne
[ESP] Portacañas

(Min. q.ty 25 pcs.)



REGGICANNE TELESCOPICO "ROCK"

- [ENG] Rod rest
[FRA] Support porte-canne
[ESP] Portacañas telescópico

(Min. q.ty 25 pcs.)



INFO	ROCK	
CODE	SIZE (CM.)	PRICE / PC
6313081	90 (CLOSED 70)	
6313082	120 (CLOSED 90)	

Art. 6301200

PICCO BIFILETTATO

- [ITA] in alluminio telescopico
chiuso cm. 90, aperto cm. 160
[ENG] Aluminium telescopic bank stick with double
thread, closed cm. 90, opened cm. 160
[FRA] Pique télescopique en aluminium filetage
double fermé 90 cm., ouvert 160 cm.
[ESP] Piqueta telescópica de aluminio cerr.
cm. 90 abierta cm. 160

(Min. q.ty 25 pcs.)



PRICE / PC

Art. 6301080

PICCO FISSO

- [ITA] Passo italiano cm. 80
[ENG] Aluminium bank stick length cm. 80
[FRA] pique fixe en aluminium 80 cm.
[ESP] Piqueta fija de aluminio cm. 80

(Min. q.ty 25 pcs.)

PRICE / PC

INFO	JUMBO	
CODE	SIZE (CM.)	PRICE / PC
6313088	80 (CLOSED 55)	
6313089	120 (CLOSED 70)	

ROD STANDS

Art. 6302200

PICCHETTO A "U"

[ITA] Telescopico reggicanna posteriore chiuso cm. 80, aperto cm. 130
 [ENG] Telescopic rod holder - back, closed cm. 80, opened cm. 130
 [FRA] Support télescopique postérieur, fermé cm. 80, ouvert cm. 130
 [ESP] Portacañas telescópico posterior cerr. cm. 80 abierto cm. 130

(Min. q.ty 50 pcs.)

PRICE / PC



Art. 6302100

PICCHETTO A "V"

[ITA] Telescopico reggicanna anteriore chiuso cm. 80, aperto cm. 130
 [ENG] Telescopic rod holder - front, closed cm. 80, opened cm. 130
 [FRA] Support télescopique antérieur, fermé cm. 80, ouvert cm. 130
 [ESP] Portacañas telescópico delantero cerr. cm. 80 abierto cm. 130

(Min. q.ty 50 pcs.)

PRICE / PC



Art. 6301152

PICCHETTO A "V"

[ITA] Reggicanna anteriore mono pezzo cm. 80
 [ENG] Monosection rod holder - front cm. 80
 [FRA] Support monosection antérieur cm. 80
 [ESP] Portacañas 1 sección delantero cm. 80

(Min. q.ty 50 pcs.)

PRICE / PC



Art. 6325...

PICCHETTO IN ALLUMINIO

[ITA] Picchetto in alluminio telescopico regolabile
 [ENG] Fully adjustable bank aluminium stick
 [FRA] Support télescopique réglable en aluminium
 [ESP] Portacañas telescópico ajustable de aluminio

(Min. q.ty 25 pcs.)

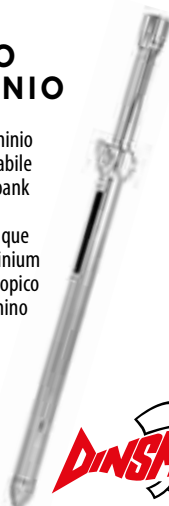

INFO PICCHETTO IN ALLUMINIO

CODE	SIZE (CM.)	PRICE / PC
6325041	40-70	
6325061	50-100	
6325076	75-140	
6325126	125-230	

Art. 630125.

PICCHETTO CON TRIVELLA

[ITA] Telescopico con trivella
 [ENG] Telescopic stick with auger
 [FRA] Support télescopique pointe à foret
 [ESP] Portacañas telescópico con barrena

(Min. q.ty 50 pcs.)



INFO PICCO TRIVELLA

CODE	SIZE (CM.)	PRICE / PC
6301250	80 (CLOSED 55)	
6301255	128 (CLOSED 75)	

PICCHETTO TELESCOPICO

[ITA] Telescopico in alluminio
 [ENG] Telescopic aluminium rod holder
 [FRA] Support télescopique aluminium.
 [ESP] Portacañas telescópico de aluminio

(Min. q.ty 50 pcs.)

INFO PICCHETTO

CODE	OPEN / CLOSED	PRICE / PC
6301150	50-90 CM	
6301151	85-160 CM	



Art. 6320015

MANICO FIOCINA CON ELASTICO

(Min. q.ty 50 pcs.)

PRICE / PC

[ITA] 1 sezione - lunghezza totale cm. 120
 [ENG] Spear handle , 1 section- total length cm. 120
 [FRA] Poignee harpon 1 section- longueur totale cm 120.
 [ESP] Mango arpón - 1 sección - largura cm. 120

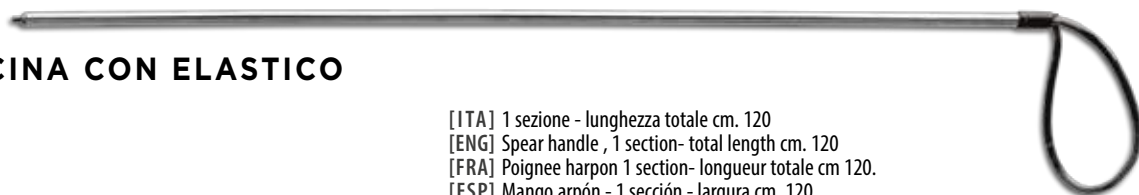

Art. 6320017

FIOCINA A 5 PUNTE

[ITA] Fiocina a 5 punte
 [ENG] 5 heads fork spear
 [FRA] Harpon à 5 pointes
 [ESP] Arpon con 5 puntas

(Min. q.ty 50 pcs.)



PRICE / PC

Art. 6320016

FIOCINA A TRIDENTE

[ITA] Fiocina a tridente
 [ENG] 3 heads fork spear
 [FRA] Harpon à 3 pointes
 [ESP] Arpon con 3 puntas

(Min. q.ty 50 pcs.)

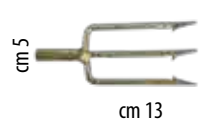

PRICE / PC

Art. 6320010

FIOCINA A TRIDENTE CON ELASTICO

(Min. q.ty 50 pcs.)

[ITA] 1 sezione - lunghezza totale cm. 120
 [ENG] 3 heads fork spear, 1 section- total length cm. 120
 [FRA] Harpon à trident, 1 section- longueur totale cm 120
 [ESP] Arpón con 3 puntas - 1 sección - largura cm. 120

PRICE / PC

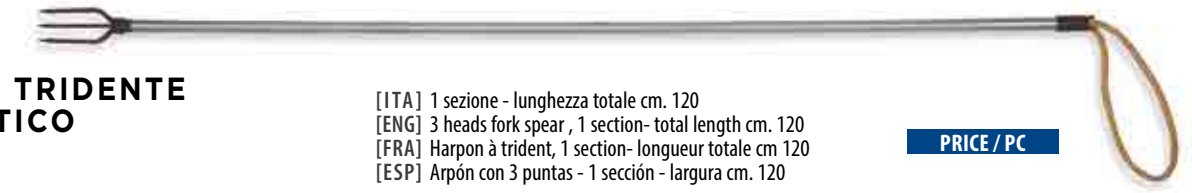

Art. 6320011

FIOCINA A 5 PUNTE CON ELASTICO

(Min. q.ty 50 pcs.)

[ITA] 1 sezione - lunghezza totale cm. 120
 [ENG] 5 heads fork spear, 1 section- total length cm. 120
 [FRA] Harpon à 5 pointes, 1 section- longueur totale cm 120
 [ESP] Arpón con 5 puntas - 1 sección - largura cm. 120

PRICE / PC

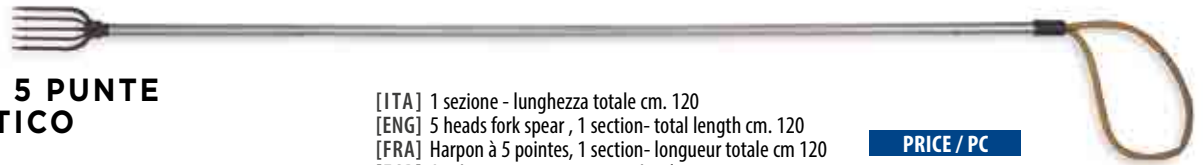

Art. 63200...

RAFFIO TELESCOPICO

[ITA] Acciaio e alluminio - in 2 pz. Misura grande specifica per prede di grossa taglia
 [ENG] Telescopic boat-hook in 2 sections, aluminium and stainless steel. Big size specific for big preys
 [FRA] Gaffe telescopique acier et aluminium - deux elements. Taille grande spécifique pour proies de grosses tailles
 [ESP] Gancho 2 elementos acero y aluminio. grande medida específica para presas grandes

(Min. q.ty 25 pcs.)

INFO	RAFFIO TELESCOPICO			
CODE	CLOSED (CM.)	OPEN (CM.)	HOOK DIAM. (MM.)	PRICE / PC
6320005	90	140	6	
6320003	133	225	8	



Art. 632002..

RAFFIO TELESCOPICO

[ITA] Acciaio e alluminio - in 2 pz.
 [ENG] Telescopic boat-hook in 2 sections, aluminium and stainless steel. Triangular section handle
 [FRA] Gaffe telescopique acier et aluminium - deux elements. Poignée à section triangulaire
 [ESP] Gancho 2 elementos acero y aluminio. Mango a seccion triangular

(Min. q.ty 25 pcs.)

INFO	RAFFIO TELESCOPICO			
CODE	CLOSED (CM.)	OPEN (CM.)	HOOK DIAM. (MM.)	PRICE / PC
6320020	90	130	6	
6320021	100	160	6	
6320022	115	200	8	



Art. 6320007

MINI RAFFIO TELESCOPICO REGOLABILE

[ITA] Acciaio e alluminio - in 2 pz. Chiuso cm. 54 - aperto cm. 72
 [ENG] Compact adjustable telescopic boat-hook in 2 sections, aluminium and stainless steel.
 Closed cm. 54 - open cm. 72
 [FRA] Gaffe telescopique réglable compact acier et aluminium - deux elements.
 Fermé cm. 54 - ouvert cm. 72
 [ESP] Gancho ajustable compacto 2 elementos acero y aluminio.
 Cerrado cm. 54 - abierto cm. 72

(Min. q.ty 25 pcs.)



PRICE / PC

Art. 6320002

RAFFIO MONOSEZIONE

(Min. q.ty 25 pcs.)

[ITA] Acciaio e fibra di vetro lunghezza totale cm. 140
 [ENG] Monosection gaff, stainless steel and fiber glass total length cm. 140
 [FRA] Gaffe monosection - acier et fibre de verre - longueur total cm 140
 [ESP] Gancho un elemento acero y fibra de vidrio cm. 140

PRICE / PC

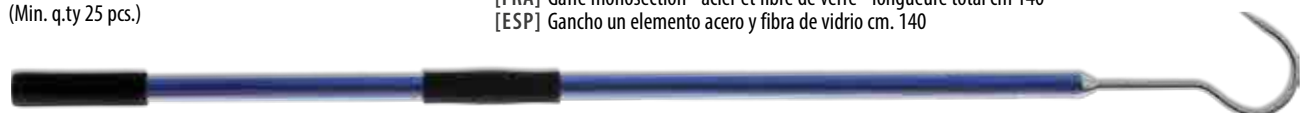

ROD STANDS

Art. 6313035

ROD POD SET

[ITA] 3 canne con fodero
 [ENG] Rod pod set 3 rods - cloth bag
 [FRA] Set rod pod 3 cannes - forreau tissu
 [ESP] Rod pod set 3 cañas - con funda

(Min. pack 5 pcs)

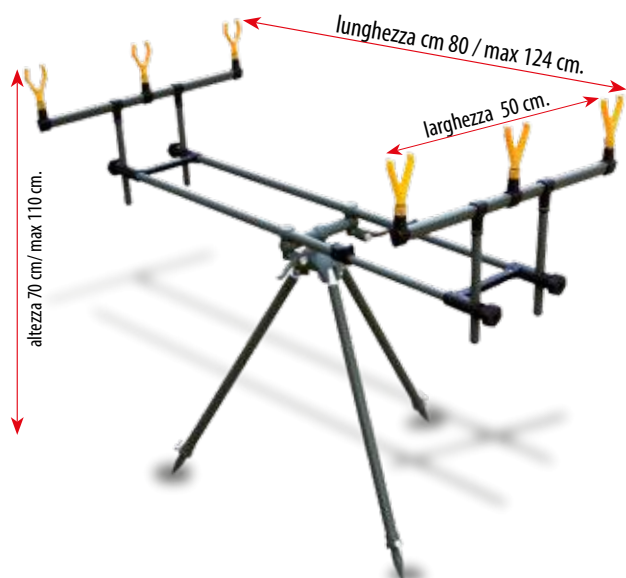

PRICE / PC

Art. 6313034

ROD POD SET

[ITA] 3 canne con fodero - piedi scorrevoli
 [ENG] Rod pod set 3 rods - sliding feet - cloth bag
 [FRA] set rod pod 3 cannes - pieds glissants - forreau tissu
 [ESP] rod pod set 3 cañas - pies corredizos - con funda

(Min. pack 5 pcs)

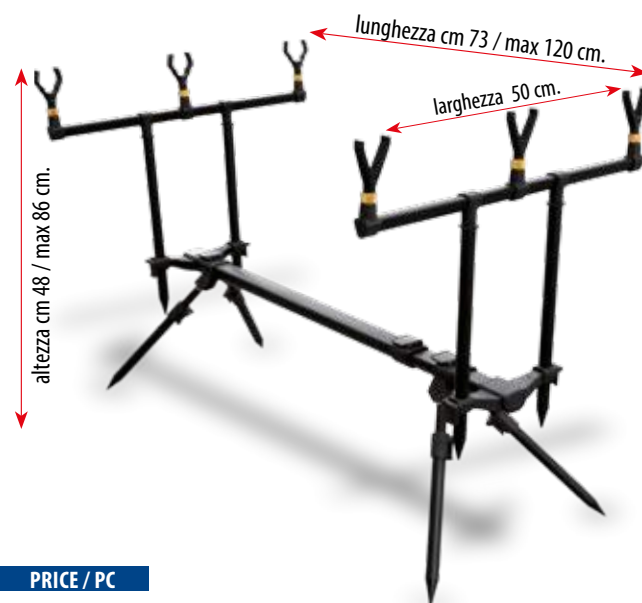

PRICE / PC

Art. 6313033

ROD POD SET

[ITA] 4 canne - con fodero
 [ENG] Rod pod set 4 rods - cloth bag
 [FRA] Set rod pod 4 cannes - fourreau tissu
 [ESP] Rod pod set 4 cañas - con funda

(Min. pack 5 pcs)

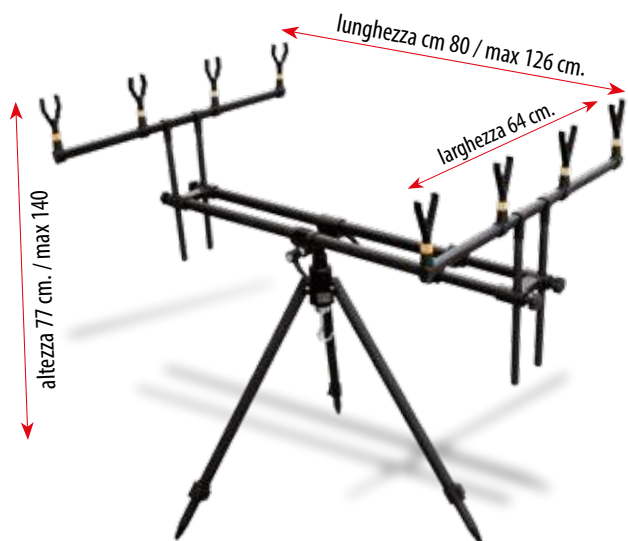

PRICE / PC

Art. 6313043

ROD POD SET SPECIAL

[ITA] 3 canne con fodero in cordura®
 [ENG] Rod pod set 3 rods - cloth bag
 [FRA] Set rod pod 3 cannes - forreau tissu
 [ESP] Rod pod set 3 cañas - funda de cordura®

(Min. pack 4 pcs)

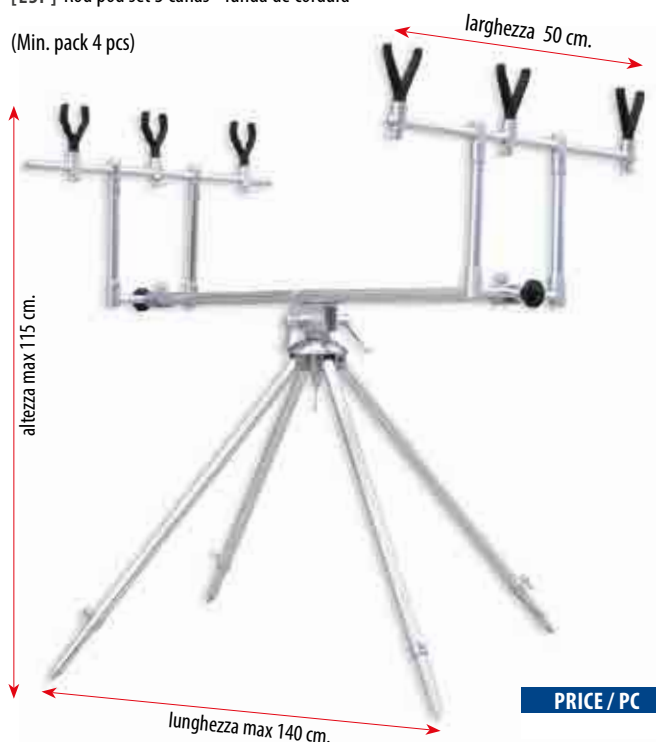

PRICE / PC

Art. 6313014

ROD POD SET

[ITA] per 3 canne - 3 swingers inclusi - con fodero
 [ENG] Rod pod set 3 rods - 3 swingers included - cloth bag
 [FRA] Set rod pod 3 cannes - 3 swingers inclus - avec fourreau
 [ESP] Rod pod set 3 cañas - 3 swingers incluidos - con funda



(Min. pack 6 pcs)

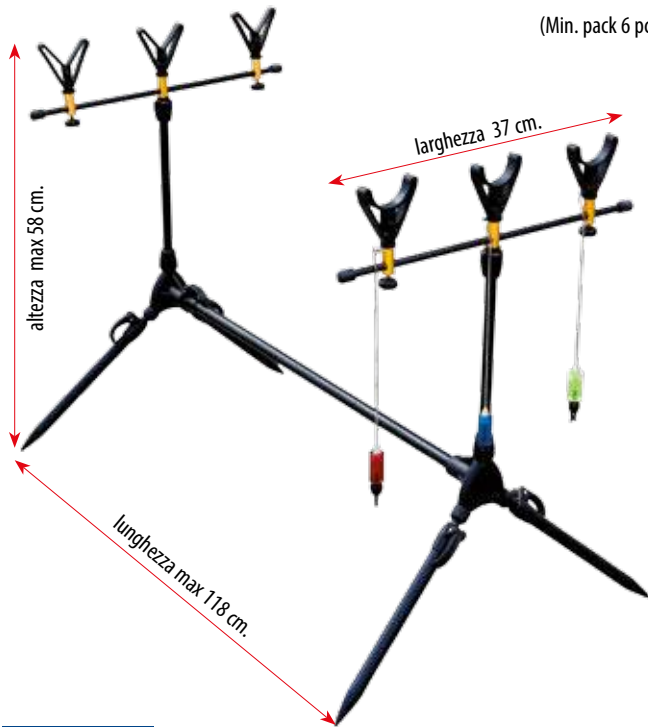

PRICE / PC

Art. 6313056

ROD POD SET

[ITA] 3 canne
 [ENG] Rod pod set 3 rods
 [FRA] Set rod pod 3 cannes
 [ESP] Rod pod set 3 cañas

(Min. pack 6 pcs)

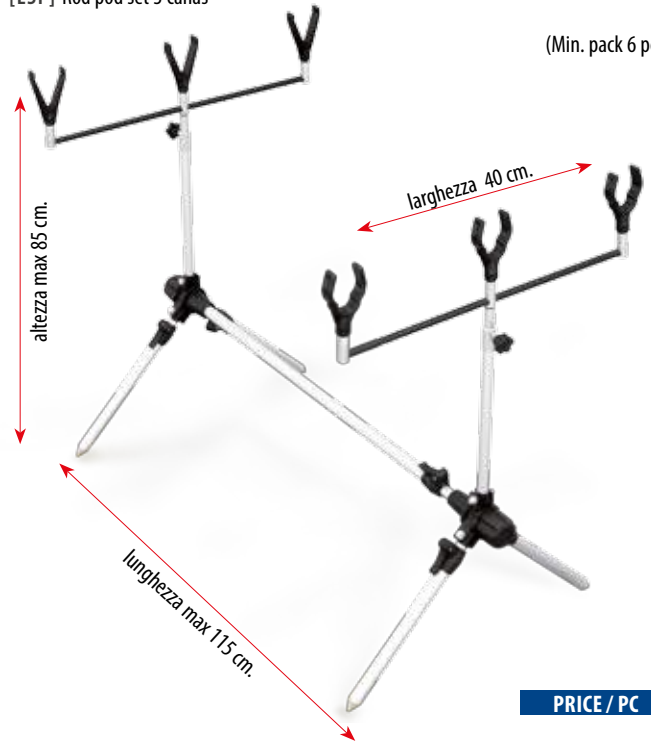

PRICE / PC

ROD POD SET

(Min. pack 6 pcs)

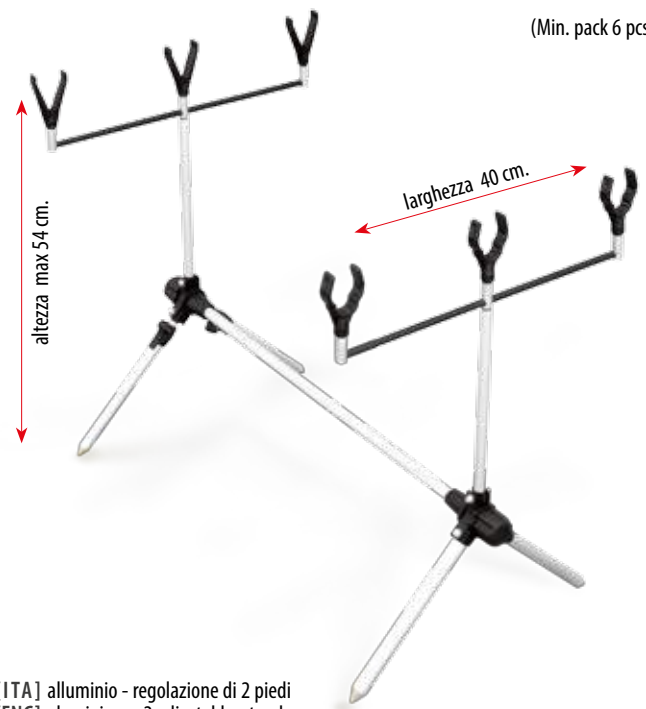

[ITA] alluminio - regolazione di 2 piedi
 [ENG] aluminium - 2 adjustable stands
 [FRA] aluminium - 2 pieds réglables
 [ESP] aluminio - 2 pies ajustables

INFO	ROD POD SET		
CODE	RODS	LENGTH CM	PRICE / PC
6313019	3	100	